

Linear

MIMI R014 Fixture Guide

KKDÖ

Indoor/Outdoor | Surface | Output up to 979lm/m (299lm/ft)



Key applications

- ✓ Architectural detail
- ✓ Bathrooms
- ✓ Building facades
- ✓ Cove lighting
- ✓ Direct lighting
- ✓ Exterior
- ✓ Hand rail
- ✓ Indirect lighting
- ✓ Wet area

Key features

- ✓ Adjustable
- ✓ Custom lengths
- ✓ Constant Voltage (CV)
- ✓ Diffusion: homogenous
- ✓ Direct view
- ✓ Extensive CCT range
- ✓ IP44 moisture resistant
- ✓ IP67 waterproof
- ✓ Nano louvre

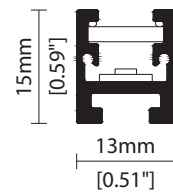

MOUNTING METHODS



KKCP-02 Clip



KKCP-14 Locking clip



KKBK-06 Fixed bracket



KKBK-05 Adjustable bracket



EB End Cap Bracket

Linear

MIMI R014

Specification sheet



Dimensions	H15/W13/L103-2020mm* (H0.59/W0.51/L4.05-79.53in*) *Nano Louvre = 1020mm/40.16in Max
PCB Cut-point	41.7mm increment/2000mm max (1.64in increment/78.74in max*) *Nano Louvre = 1000mm/39.37in Max
LED Pitch	6.95mm-144LED/m (0.27in - 44LED/ft)
Chip	s-line k-line
Cover/Optics	Clear (75°)/Diffused (95°)/Nano louvre (35°)/Black (63°)
CCT	s-line: 1900K/2100K/2300K/2500K/2700K/3000K/3500K/4000K/5000K Single colours: Red/Green/Blue/Orange/Amber k-line: 1900K/2100K/2300K/2500K/2700K/3000K/3500K/4000K/5000K
LED binning	s-line: 2-step MacAdam ellipse k-line: 3-step MacAdam ellipse
CRI	≥ 92
Lifetime	50,000 hours @ 25°C (50,000 hours @ 77°F)
Operating temp	T _a = -25 to 50°C (T _c max = 68°C) T _a = -13 to 122°F (T _c max = 154°F)
IP Rating	IP44/IP67
Finish	Silver anodised
Mounting	Surface mounting via clips or brackets
Power feed	Sheathed hardwire tails or male/female connectors
Control	0-10V/1-10V/DMX/DALI



LED Grading Key

Exclusive Grade

s s-line*	*KKDC tuned CCT range
2-step CCT range	

Base Grade

k k-line	3-step commercial range Energy Star CCTs
-----------------	---

Power consumption	Supply voltage	Supply current
14W/m (4.27W/ft)	24V DC	0.58A/m (0.18A/ft)

Performance Data (3000K)

	R1	R2	R3	R4	R5	R6	R7	R8	R9	R10	R11	R12	R13	R14
k-line	93	96	97	91	92	94	92	84	64	91	91	73	94	98

	Clear	Diffused	Diffused + Nano Louvre	Black	CRI	R9	Rf	Rg
s-line	979lm/m (299lm/ft) 70lm/W	772lm/m (235lm/ft) 55.1lm/W	267lm/m (81lm/ft) 19.1lm/W	401lm/m (122lm/ft) 28.6lm/W	93	65	-	-
k-line	924lm/m (282lm/ft) 66lm/W	728lm/m (222lm/ft) 52lm/W	252lm/m (77lm/ft) 18lm/W	378lm/m (115lm/ft) 27lm/W	92	64	-	-

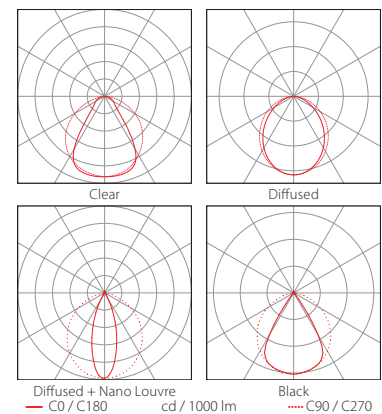
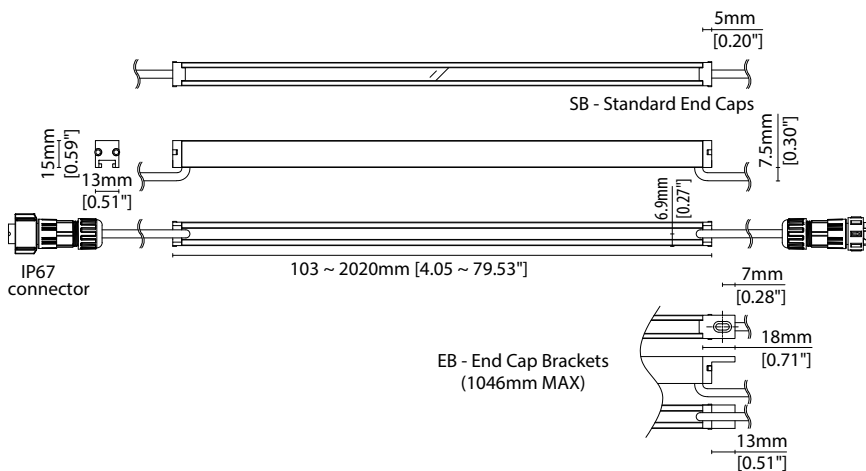

Data derived from independent UKAS/IESNA LM-79-08 accredited testing of production samples.

FIXTURE

Model	Finish	Cover ¹	Grade ²	LED	Colour (CCT)	Length Availability ³	IP	Cable Length	Power Feed ⁴	Fixing	Input
MIMI MI	Silver Anodised SA	Clear B	s	R014 R014	1900K 19	m 103-2020mm 83.3mm increments	IP44 44 IP67 ⁷ 67	300mm/ 11.81" 0300	Single ø4.3mm sheath tail S00A	Standard End Cap SB	DC 24V g
		Diffused C	k		2100K 21				Double ø4.3mm sheath tail D00A	End Cap Bracket EB	
		Diffused + Nano Louvre ^{5,6} CN			2300K 23	i 4.05-79.53in 3.28in increments			Single ø4.3mm sheath IP67 connector S67A		
		Black Y			2500K 25	(Specify length code OR total run length)			Double ø4.3mm sheath IP67 connector D67A		
					2700K 27						
					3000K 30						
					3500K 35						
					4000K 40						
					5000K 50						
					RED RED s-only						
					GREEN GRN						
					BLUE BLU						
					ORANGE ORN						
					AMBER AMB						

¹ Refer to **Cover Options** on **Options** pages ² Refer to **LED Grading Key** on **Specification sheet** page ³ Refer to **Length Availability List** or enter total run length instead of length code
⁴ Refer to **Power Feed Options** on **Options** pages ⁵ Max length available with Nano Louvre is 1020mm
⁶ Nano Louvre suitable for IP44 variant ONLY. Prolonged exposure to water droplets on cover surface may result in superficial peeling of Nano louvre film without affecting integrity of housing ingress
⁷ Due to the clear, flush potted polyurethane top layer on IP67 MIMI a colour shift of +/-20K should be expected

Code Example:

MI	-	SA	-	CN	-	s	-	R014	-	35	-	m	-	520	-	67	-	0300	-	S00A	-	EB	-	g
MIMI		Silver Anodised		Diffused + Nano Louvre		s		R014		3500K		520mm		IP67		300mm/11.81"		0300		Single ø4.3mm sheath tail		End Cap Bracket		DC 24V

ACCESSORIES

Mounting Accessories

KKCP-02	Clip (1no.)
KKCP-52	Clip (500no.)
KKCP-14	Lock Clip
KKBK-06	Fixed bracket
KKBK-05	Adjustable bracket

* Refer to **Mounting accessories** on **Accessories** pages

Connection Accessories

CN67-2P-0300	IP67 2 PIN male & female 300mm/11.81" pair
CN67-2P-1000	IP67 2 PIN male & female 1000mm/39.37" pair
CN67-2P-3000	IP67 2 PIN male & female 3000mm/118.11" pair

* Refer to **Power feed** on **Accessories** pages

Exterior Junction Boxes

KKJB-07	IP67 Slim J-Box
KKJB-07R	Potting Resin for IP67 Slim J-Box

* Refer to **Exterior Junction Boxes** on **Accessories** pages

PSU/Driver

0-10V/1-10V/DALI/DMX

* Refer to **Driver/PSU Options** page for details or provide requirement and KKDC to offer the suitable option

LED ENGINE VARIANTS (LED STRIP TYPE)

Colour	LED	Lumen/m	Lumen/ft	W/m	W/ft	Spec Doc	Length	Increment
Single CCT	R007	475	145	7	2.13	MIMI R007	103-2020mm (4.05-79.53in)	41.7mm (1.64in)
	A010	920	280	10	3.05	MIMI A010	97-2020mm (3.82-79.53in)	38.46mm (1.51in)
	R014	979	299	14	4.27	MIMI R014	103-2020mm (4.05-79.53in)	41.7mm (1.64in)
Warm Dim/Dynamic White	R020	1208	368	20	6.10	MIMI R020	103-2020mm (4.05-79.53in)	41.7mm (1.64in)
	A020	1840	561	20	6.10	MIMI A020	97-2020mm (3.82-79.53in)	38.46mm (1.51in)
	R207	984	300	16	4.88	MIMI R207	103-2020mm (4.05-79.53in)	83.3mm (3.28in)
RGB	501	Red 98 Green 210 Blue 35 RGB 305	Red 30 Green 64 Blue 11 RGB 93	15.6	4.75	MIMI RGB	103-2020mm (4.05-79.53in)	83.3mm (3.28in)

* Performance data: A/s-line, clear cover, 3000K

MIMI R014

Length Availability List



Length Code		Fixture Length ¹		LED Strip ²		End Cap Dimension		Wattage (W)	Output (lm)
Metric	Imperial(US)	Metric	Imperial(US)	Metric	Imperial(US)	Metric	Imperial(US)		3000K (Test Data)
m0103	i0004	103mm	4.07in	83mm	3.28in	10mm	0.39in	1.17	77
m0145	i0006	145mm	5.71in	125mm	4.92in	10mm	0.39in	1.75	116
m0187	i0007	187mm	7.35in	167mm	6.56in	10mm	0.39in	2.33	154
m0228	i0009	228mm	8.99in	208mm	8.20in	10mm	0.39in	2.92	192
m0270	i0011	270mm	10.63in	250mm	9.84in	10mm	0.39in	3.50	231
m0312	i0012	312mm	12.27in	292mm	11.48in	10mm	0.39in	4.08	269
m0353	i0014	353mm	13.91in	333mm	13.12in	10mm	0.39in	4.67	308
m0395	i0016	395mm	15.55in	375mm	14.76in	10mm	0.39in	5.25	346
m0437	i0017	437mm	17.19in	417mm	16.40in	10mm	0.39in	5.83	385
m0478	i0019	478mm	18.83in	458mm	18.04in	10mm	0.39in	6.42	423
m0520	i0020	520mm	20.47in	500mm	19.69in	10mm	0.39in	7.00	462
m0562	i0022	562mm	22.11in	542mm	21.33in	10mm	0.39in	7.58	500
m0603	i0024	603mm	23.75in	583mm	22.97in	10mm	0.39in	8.17	539
m0645	i0025	645mm	25.39in	625mm	24.61in	10mm	0.39in	8.75	577
m0687	i0027	687mm	27.03in	667mm	26.25in	10mm	0.39in	9.33	616
m0728	i0029	728mm	28.67in	708mm	27.89in	10mm	0.39in	9.92	654
m0770	i0030	770mm	30.31in	750mm	29.53in	10mm	0.39in	10.50	693
m0812	i0032	812mm	31.96in	792mm	31.17in	10mm	0.39in	11.08	731
m0853	i0034	853mm	33.60in	833mm	32.81in	10mm	0.39in	11.67	770
m0895	i0035	895mm	35.24in	875mm	34.45in	10mm	0.39in	12.25	808
m0937	i0037	937mm	36.88in	917mm	36.09in	10mm	0.39in	12.83	847
m0978	i0039	978mm	38.52in	958mm	37.73in	10mm	0.39in	13.42	885
m1020	i0040	1020mm	40.16in	1000mm	39.37in	10mm	0.39in	14.00	924
m1062	i0042	1062mm	41.80in	1042mm	41.01in	10mm	0.39in	14.58	962
m1103	i0043	1103mm	43.44in	1083mm	42.65in	10mm	0.39in	15.17	1001
m1145	i0045	1145mm	45.08in	1125mm	44.29in	10mm	0.39in	15.75	1039
m1187	i0047	1187mm	46.72in	1167mm	45.93in	10mm	0.39in	16.33	1078
m1228	i0048	1228mm	48.36in	1208mm	47.57in	10mm	0.39in	16.92	1116
m1270	i0050	1270mm	50.00in	1250mm	49.21in	10mm	0.39in	17.50	1155
m1312	i0052	1312mm	51.64in	1292mm	50.85in	10mm	0.39in	18.08	1193
m1353	i0053	1353mm	53.28in	1333mm	52.49in	10mm	0.39in	18.67	1232
m1395	i0055	1395mm	54.92in	1375mm	54.13in	10mm	0.39in	19.25	1270
m1437	i0057	1437mm	56.56in	1417mm	55.77in	10mm	0.39in	19.83	1309
m1478	i0058	1478mm	58.20in	1458mm	57.41in	10mm	0.39in	20.42	1347
m1520	i0060	1520mm	59.84in	1500mm	59.06in	10mm	0.39in	21.00	1386
m1562	i0061	1562mm	61.48in	1542mm	60.70in	10mm	0.39in	21.58	1424
m1603	i0063	1603mm	63.12in	1583mm	62.34in	10mm	0.39in	22.17	1463
m1645	i0065	1645mm	64.76in	1625mm	63.98in	10mm	0.39in	22.75	1501
m1687	i0066	1687mm	66.40in	1667mm	65.62in	10mm	0.39in	23.33	1540
m1728	i0068	1728mm	68.04in	1708mm	67.26in	10mm	0.39in	23.92	1578
m1770	i0070	1770mm	69.69in	1750mm	68.90in	10mm	0.39in	24.50	1617
m1812	i0071	1812mm	71.33in	1792mm	70.54in	10mm	0.39in	25.08	1655
m1853	i0073	1853mm	72.97in	1833mm	72.18in	10mm	0.39in	25.67	1694

MIMI R014

Length Availability List



Length Code		Fixture Length ¹		LED Strip ²		End Cap Dimension		Wattage (W)	Output (lm)
Metric	Imperial(US)	Metric	Imperial(US)	Metric	Imperial(US)	Metric	Imperial(US)		3000K (Test Data)
m1895	i0075	1895mm	74.61in	1875mm	73.82in	10mm	0.39in	26.25	1732
m1937	i0076	1937mm	76.25in	1917mm	75.46in	10mm	0.39in	26.83	1771
m1978	i0078	1978mm	77.89in	1958mm	77.10in	10mm	0.39in	27.42	1809
m2020	i0080	2020mm	79.53in	2000mm	78.74in	10mm	0.39in	28.00	1848

¹ Actual total overall length of light fixture (LED strip + end caps + void/wire hole)

² Actual length of PCB strip

³ Actual length of 2x end caps

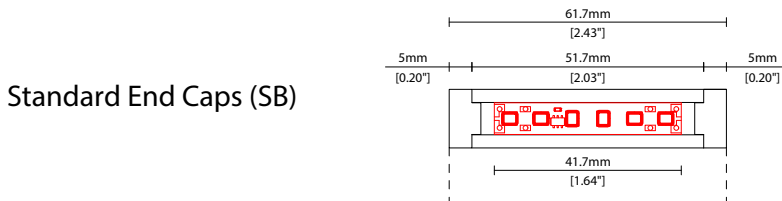

***End Cap Brackets (EB)**
Increases overall standard length by 26mm (2x13mm)

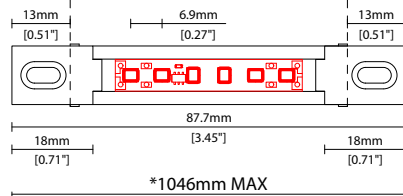

***IMPORTANT NOTE:**
DUE TO POTENTIAL PROFILE 'SAGGING' THE MAX LENGTH AVAILABLE WITH END CAP BRACKETS IS 1046mm.

COVER OPTIONS

* Options are an integral part of the fixture ordering codes. Please refer to **Code Table** pages.

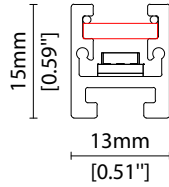

B Clear Cover
Polycarbonate
W13/H15mm (W0.51"/H0.59")

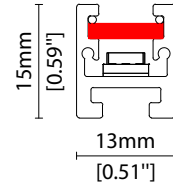
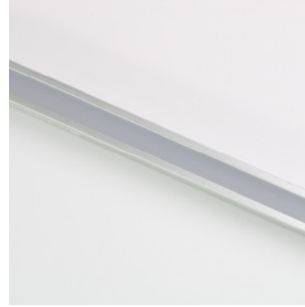

C Diffused Cover
Polycarbonate finish
W13/H15mm (W0.51"/H0.59")

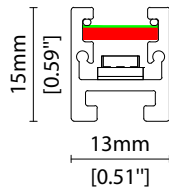

CN Diffused Cover + Nano Louvre
Polycarbonate cover with anti-glare, 30° cut-off view angle
W13/H15mm (W0.51"/H0.59")

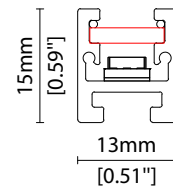

Y Black Clear Cover
Dark tinted translucent polycarbonate
60% light output
W13/H15mm (W0.51"/H0.59")

END CAP OPTION

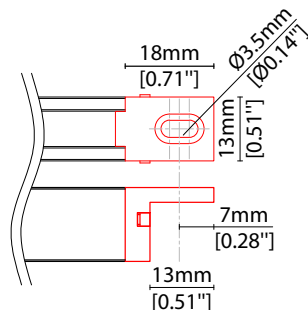

EB End Cap Bracket (Pair)
Handrail installation
Compatible up to 1m/40"
L18/W13/H15mm
(L0.7/W0.51/H0.59")

POWER FEED OPTIONS

* Options are an integral part of the fixture ordering codes. Please refer to **Code Table** pages.

0300 S00A 300mm (11.81") Single \varnothing 4.3mm sheath tail

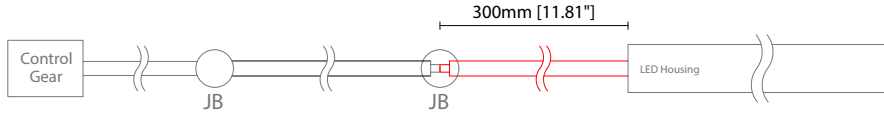

0300 D00A 300mm (11.81") Double \varnothing 4.3mm sheath tail

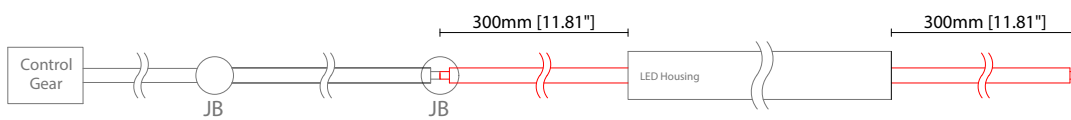

0300 S67A 300mm (11.81") Single \varnothing 4.3mm sheath IP67 connector

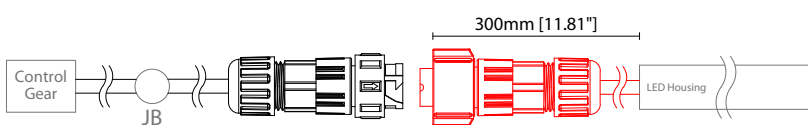

0300 D67A 300mm (11.81") Double \varnothing 4.3mm sheath IP67 connector

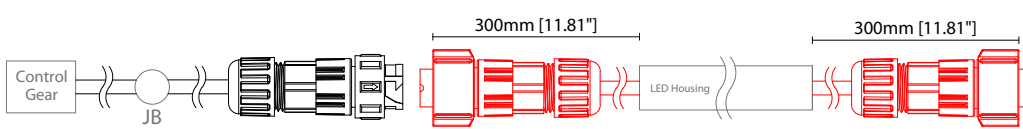

IP67 2 Pin Connector

Female connector
2 PIN (IP67)

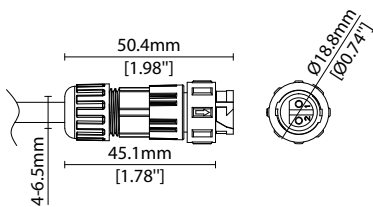

Male connector
2 PIN (IP67)

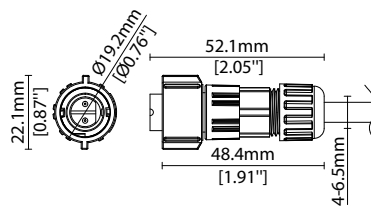

Key

- Control Gear Power supply, sub-controllers & control systems
- JB Junction box / cable connection

MOUNTING ACCESSORIES

Note: Accessories are to be ordered separately with corresponding code shown below.



KKCP-02 (1no.)
KKCP-52 (500no.)
Clip (allow 3 per metre/40in)
S/Steel finish
L25/W16.7/H15.5mm
(L0.98/W0.66/H0.61")

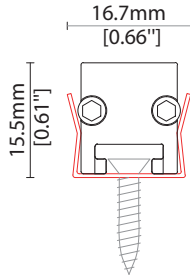

KKCP-14
Lock clip (allow 2 per metre/40in)
S/Steel finish
L25/W14/H21mm
(L0.98/W0.55/H0.83")

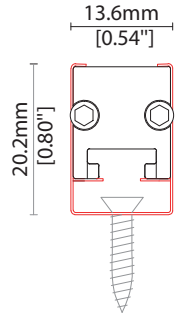

KKBK-06
Fixed bracket (allow 3 per metre/40in)
S/Steel finish
L20/W29.1/H28.8mm
L0.79/W1.15/H1.13"

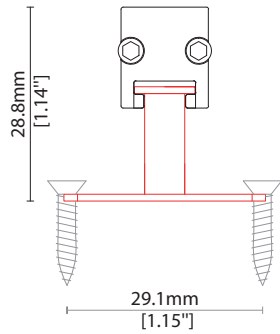

KKBK-05
Adjustable bracket (allow 2 per metre/40in)
S/Steel finish
W13/H32.9mm
W0.51/H1.3"

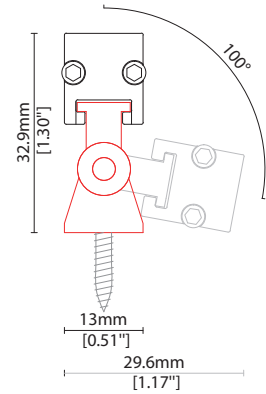

POWER FEED

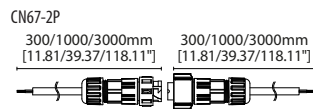

CN67-2P-0300 300mm (11.81in) pair
CN67-2P-1000 1000mm (39.37in) pair
CN67-2P-3000 3000mm (118.11in) pair
IP67
2 PIN male + female connector set

EXTERIOR JUNCTION BOXES



KKJB-07

IP67 Slim J-Box
(including type A,B,C, D bushings)



KKJB-07R

Potting resin for IP67 Slim J-Box

KKDC CONTROL



KKDM-06 1-10V

visDIM dimmable sub-controller
(4 x 8A max @ 12-36V)

IP20
Plastic housing
L170/W59/H29mm
(L6.69/W2.32/H1.14in)



KKSC-05 DMX

visDIM dimmable sub-controller
(4 x 5A max @ 12-36V)

IP20
Plastic housing
L170/W53.4/H28mm
(L6.69/W2.10/H1.10in)



KKDL-02 DALI

visDIM dimmable sub-controller
(4 x 8A max @ 12-36V)

IP20
Plastic housing
L170/W59/H29mm
(L6.69/W2.32/H1.14in)



KKDL-03 DALI

visDIM dimmable sub-controller
(4 x 5A max @ 12-36V)

IP20
Plastic housing
L166/W53.4/H23mm
(L6.54/W2.10/H0.91in)

AVAILABLE PSU OPTIONS

Control Mode	PSU (Order Code)	Input Voltage AC	Output Voltage DC	Rated Output Current	Rated Power	Dim %	IP Rating
Switched	CEN-60-24	90-295V	24V	2.5A	60W	-	IP67
	HLG-60H-24	90-305V	24V	2.5A	60W	-	IP67
	HLG-100H-24	90-305V	24V	4.0A	100W	-	IP67
	HLG-150H-24	90-305V	24V	6.3A	150W	-	IP67
	HLG-240H-24	90-305V	24V	10A	240W	-	IP67
0-10V (1-10V)	PWM-40-24	90-305V	24V	1.67A	40W	100-0.15 (100-10)	IP67
	PWM-60-24	90-305V	24V	2.5A	60W	100-0.15 (100-10)	IP67
	PWM-90-24	90-305V	24V	3.67A	90W	100-0.15 (100-10)	IP67
	PWM-120-24	90-305V	24V	5.0A	120W	100-0.15 (100-10)	IP67
DALI	LIN100A1	120-277V	24V	1A per channel	100W	100-0.1	IP66/IP40
DMX RGB	LIN100A1	120-277V	24V	1.33A per channel	100W	100-0.1	IP66/IP40
DMX RGBW	LIN100A1	120-277A	24V	1A per channel	100W	100-0.1	IP66/IP40

Flicker Free Options - Combination of PSU+ sub-controller

Control Mode	PSU (Order Code)	Sub-controller (Order Code)	Input Voltage AC	Output Voltage DC	Rated Output Current	Rated Power	Dim %	IP Rating PSU/ Sub-controller
0-10V or 1-10V	CEN-60-24	KKDM-06	90-295V	24V	2.5A	60W	100-0.9	IP67/IP20
	HLG-60H-24	KKDM-06	90-295V	24V	2.5A	60W	100-0.9	IP67/IP20
	HLG-100H-24	KKDM-06	90-295V	24V	4.0A	100W	100-0.9	IP67/IP20
	HLG-150H-24	KKDM-06	90-295V	24V	6.3A	150W	100-0.9	IP67/IP20
	HLG-240H-24	KKDM-06	90-295V	24V	10.0A	240W	100-0.9	IP67/IP20
DALI	CEN-60-24	KKDL-02/03	90-295V	24V	2.5A	60W	100-0.1	IP67/IP20
	HLG-60H-24	KKDL-02/03	90-305V	24V	2.5A	60W	100-0.1	IP67/IP20
	HLG-100H-24	KKDL-02/03	90-305V	24V	4.0A	100W	100-0.1	IP67/IP20
	HLG-150H-24	KKDL-02/03	90-305V	24V	6.3A	150W	100-0.1	IP67/IP20
	HLG-240H-24	KKDL-02/03	90-305V	24V	10.0A	240W	100-0.1	IP67/IP20
DMX RGB	CEN-60-24	KKSC-05	90-295V	24V	2.5A	60W	100-0.9	IP67/IP20
	HLG-60H-24	KKSC-05	90-305V	24V	2.5A	60W	100-0.9	IP67/IP20
	HLG-100H-24	KKSC-05	90-305V	24V	4A	100W	100-0.9	IP67/IP20
	HLG-150H-24	KKSC-05	90-305V	24V	6.3A	150W	100-0.9	IP67/IP20
	HLG-240H-24	KKSC-05	90-305V	24V	10.0A	240W	100-0.9	IP67/IP20

¹ The items shown above cover the most frequently used specification but does not exhaust the possible options

² PSU and/or driver can be chosen from the table, or KKDC may recommend the best option upon receipt of the controls requirement and installation environment

³ Electrical shop drawing will include detailed information of PSU and relevant control drivers

⁴ Cut sheets are available on the controls section of www.kkdc.lighting or upon request